

Framing Information: TR 42 OD (Screen)

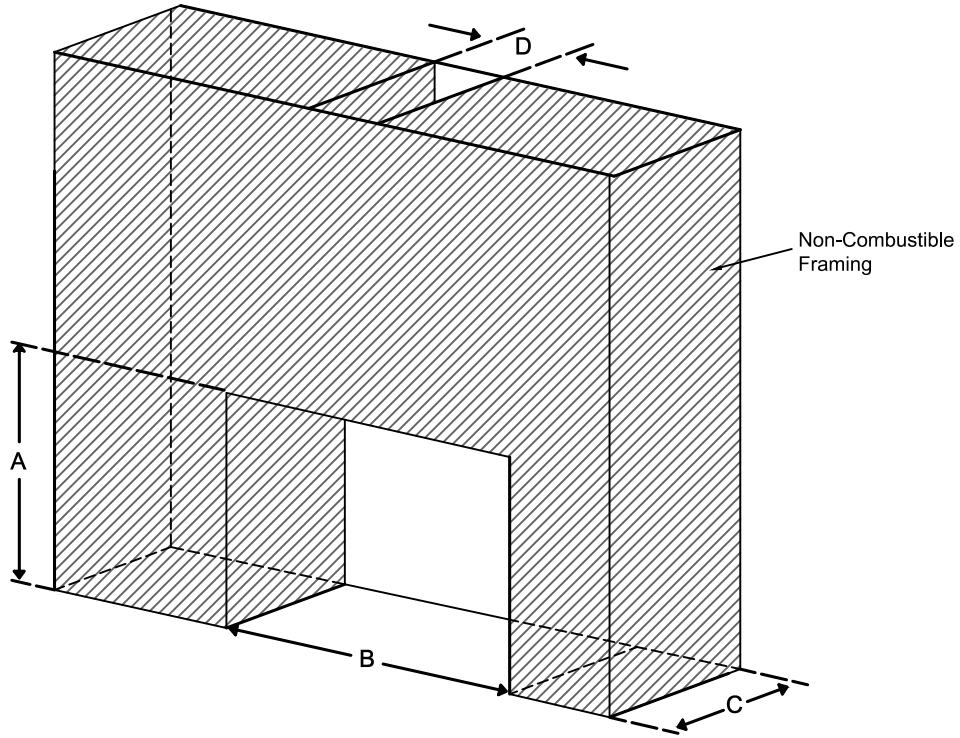

Minimum Framing Dimensions



Model	A	B	C	D
TR 42	47 ³ / ₈ "	59 ³ / ₈ "	26 ¹ / ₂ "	Refer to Vent Manufacturer's Firestop Dimensions

Note :

1. Drawings are not to Scale
2. All dimensions in inches
3. No weight can be transferred to the fireplace. ALL FRAMING MUST BE SELF-SUPPORTED.

Framing Information: TR 42 OD (Screen)

ORTAL
YOUR LIFE. YOUR FIRE

Framing Details

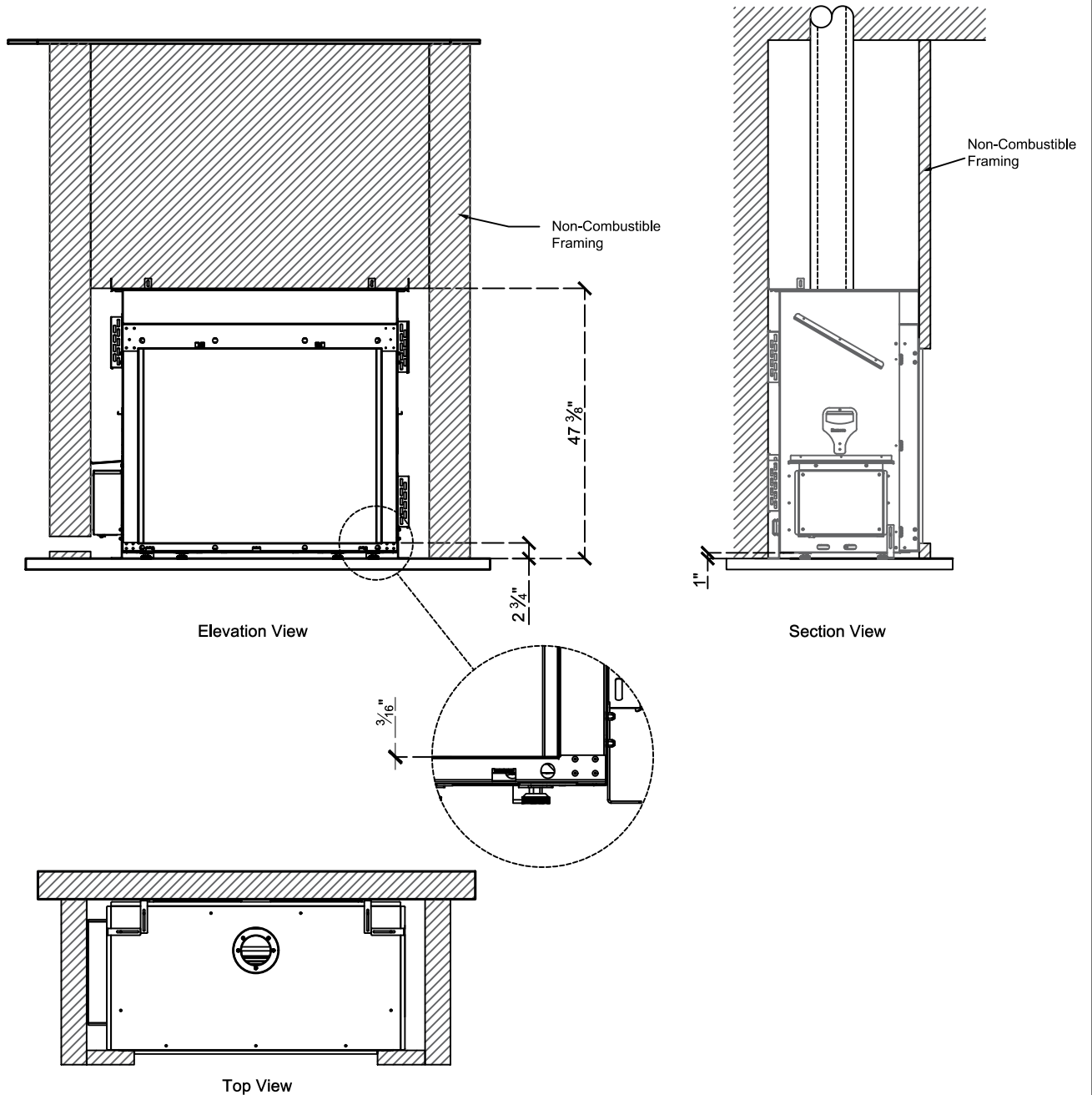

- Note :
1. Drawings are not to Scale
 2. All dimensions in inches
 3. No weight can be transferred to the fireplace. ALL FRAMING MUST BE SELF-SUPPORTED.

Framing Information: TR 42 OD (Screen)



Fireplace Dimensions

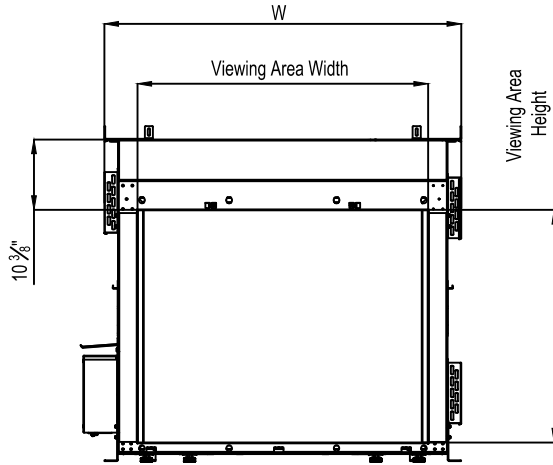

Front View

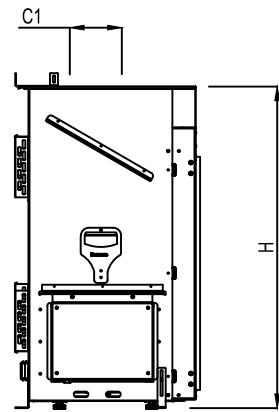

Side View

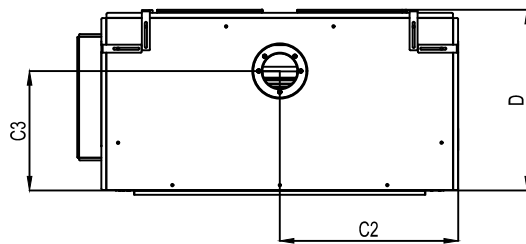

Top View

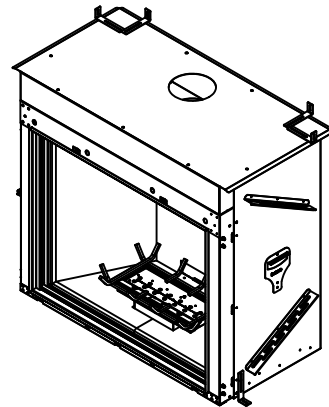

Model	(H) Height	(W) Width	(D) Depth	C1	C2	C3	Viewing Area	
							Front	Side
TR 42	47 1/8"	52 3/8"	26 1/2"	7 7/8"	26 3/16"	17 1/2"	42 3/4" W X 34 1/4" H	—

Note : 1. Drawings are not to Scale
2. All dimensions in inches